

SOLID SURFACE BITS

ROMAN OGEE UNDERMOUNT BOWL BIT

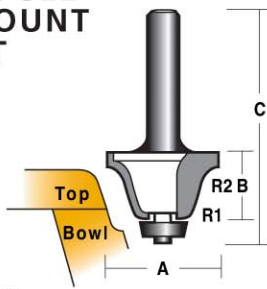

CARBIDE TIPPED
TWO FLUTES - WITH
CARBI-SMOOTH BEARING
ASSEMBLY & BALL BEARING GUIDE
12.7 mm (1/2") SHANK

PART No.	A	B	C	R1	R2
TSS 5 B 1/2	50.8	25.4	85	5/32	3/8

Replacement Bearing Assembly TBT19.

ROUNDING OVER UNDERMOUNT BOWL BIT

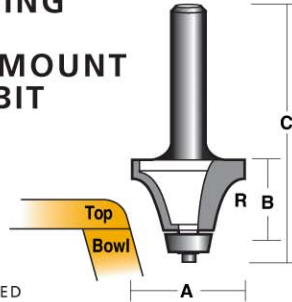

CARBIDE TIPPED
TWO FLUTES - WITH
CARBI-SMOOTH BEARING
ASSEMBLY & BALL BEARING GUIDE
12.7 mm (1/2") SHANK

PART No.	A	B	C	R RADIUS
TSS 6 B 1/2	44.5	25.4	85	9.5

Replacement Bearing Assembly TBT19.

BULLNOSE BIT SET. INVERTED ROUNDING OVER BIT

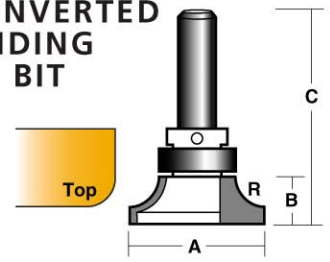

CARBIDE TIPPED
TWO FLUTES - WITH BALL BEARING GUIDE
12.7 mm (1/2") SHANK

PART No.	A	B	C	R RADIUS
TSS 7 B 1/2	60.3	22.2	80	16
TSS 9 B 1/2	66.7	24.1	82	19

Replacement Bearing TB18.

ROUNDING OVER BIT

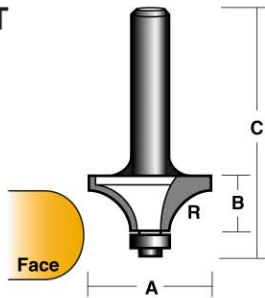

CARBIDE TIPPED
TWO FLUTES - WITH CARBI-SMOOTH
BEARING ASSEMBLY & BALL BEARING GUIDE
12.7 mm (1/2") SHANK

PART No.	A	B	C	R RADIUS
TSS 8 B 1/2	47.6	20.6	80	16
TSS 10 B 1/2	54	25.4	84	19

Replacement Bearing Assembly TBT20.

FACE INLAY BIT

1/4" WIDTH-1/2" WIDTH

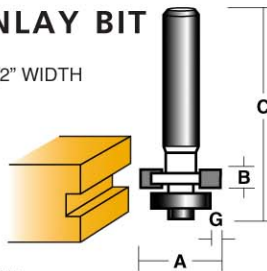

CARBIDE TIPPED
TWO FLUTES - WITH
CARBI-SMOOTH BEARING
ASSEMBLY & BALL BEARING GUIDE
12.7 mm (1/2") SHANK

PART No.	A	B	C	G	BRG ASS
TSS 11 B 1/2	25.4	1/4"	66	1.6	TBT 22
TSS 21 B 1/2	25.4	1/4"	66	3.2	TBT 21
TSS 31 B 1/2	25.4	1/4"	66	4.8	TBT 20
TSS 12 B 1/2	25.4	1/2"	73	1.6	TBT 22
TSS 22 B 1/2	25.4	1/2"	73	3.2	TBT 21
TSS 32 B 1/2	25.4	1/2"	72	4.8	TBT 20

SURFACE PLANER

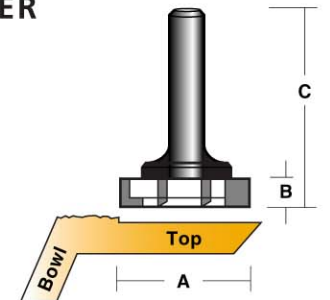

CARBIDE TIPPED - SIX FLUTES
12.7 mm (1/2") SHANK

PART No.	A	B	C
TSS 13 1/2	50.8	9.5	80

CHAMFER BIT 15°

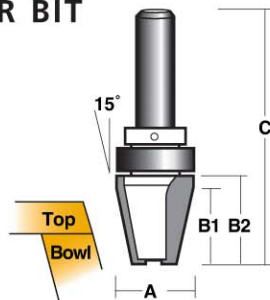

CARBIDE TIPPED
TWO FLUTES -
WITH BALL
BEARING GUIDE
**12.7 mm
(1/2") SHANK**

PART No.	A	B1	B2	C
TSS 14 B 1/2	28.6	25.4	28.4	85

Replacement Ball Bearing TB18.

BOWL CUTTER 15°

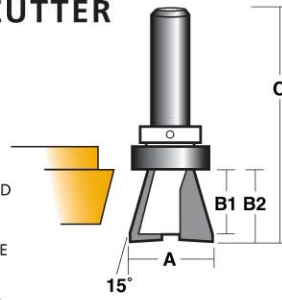

CARBIDE TIPPED
TWO FLUTES -
WITH BALL
BEARING GUIDE
**12.7 mm
(1/2") SHANK**

PART No.	A	B1	B2	C
TSS 15 B 1/2	28.6	23.5	25.4	85

Replacement Ball Bearing TB18.

COUNTER TOP BIT

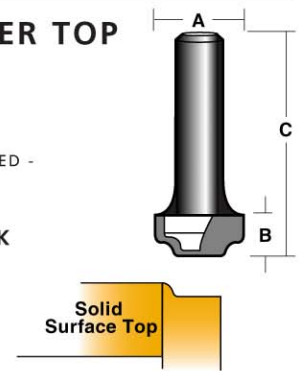

CARBIDE TIPPED -
TWO FLUTE
**12.7mm
(1/2") SHANK**

PART No.	A	B	C
TSS 16 1/2	23.8	9.5	54

BEVEL BIT

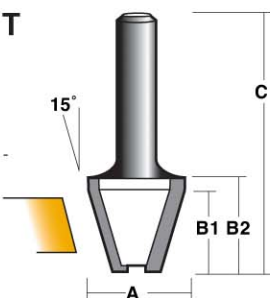

CARBIDE TIPPED -
TWO FLUTE
**12.7mm
(1/2") SHANK**

PART No.	A	B1	B2	C
TSS 17 1/2	25.4	25.4	28.4	79.4

OVERHANG TRIM BIT

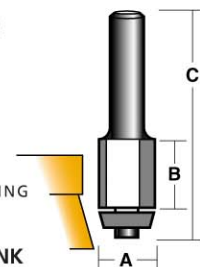

CARBIDE TIPPED -
TWO FLUTE WITH
CARBI-SMOOTH BEARING
ASSEMBLY & BALL
BEARING GUIDE
12.7mm (1/2") SHANK

PART No.	A	B	C
TSS 18 B 1/2	19	25.9	87

Replacement Bearing Assembly TBT19.

FLUSH TRIM BIT

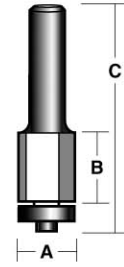

CARBIDE TIPPED - TWO FLUTE
WITH CARBI-SMOOTH
BEARING ASSEMBLY & BALL
BEARING GUIDE
12.7mm (1/2") SHANK

PART No.	A	B	C
TSS 19 B 1/2	19	25.9	87

Replacement Bearing Assembly TBT21.

